



RELIABLE
STORAGE SYSTEMS

Electric Stacker



*One Stop Storage Solution
In Material Handling Equipments*

RMS 15UX

➔ walkie stacker RMS 15UX helps the operator increase productivity, while providing operator comfort and serviceability. It allows various performance modes and valuable features to increase operator productivity.

PRODUCTIVITY

- Maintenance free AC motor
- Multi-function display with BDI and hour meter
- Emergency reversing button
- Auto deceleration function
- Low speed switch
- Variable speed control
- Sideways battery removal with rollers
- Mast cushioning for low-noise operation
- Built-in pressure relief valve protects from overloads
- Emergency power disconnect switch
- Cold store configuration (option)

OPTIMUM STRUCTURAL DESIGN

- Low centre of gravity enhances stability
- Full free lift mast options for low overhead clearance
- Durable plastic covers
- Adjustable balance casters improve stability

SERVICEABILITY

- Low voltage protection setting extends the battery life
- CANbus technology
- Simple electronic components makes troubleshooting and servicing more efficient
- Hall effect sensors reduce wear and increase component life



Handle (Standard)
(Left & Right Handed)



Fork Lengths to Suit
All Applications



One Sided (Cold Store)



Two Sided (Cold Store)

LOAD CHARTS

LOAD CENTRE CHART

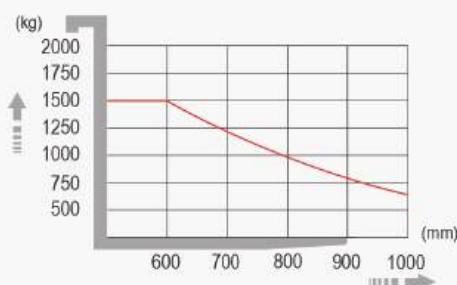

LOAD CAPACITY CHART

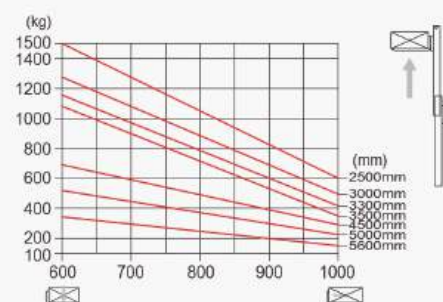

SPECIFICATIONS AND DIMENSIONS

Model	Measurement	RMS15UX
Load capacity	Q (kg)	1500
Load centre distance	c (mm)	600
Load distance, centre of drive axle to fork	x (mm)	697
Wheelbase	y (mm)	1410
Fork height, lowered	h13 (mm)	90
Tyre size, front	mm	250x70
Tyre size, rear	mm	80x84
Additional wheels (dimensions)	mm	150x60
Wheels, number front rear (x=driven wheels)		1x+1/4
Height, mast lowered	h1 (mm)	1985
Free lift (option 2500~3500mm)	h2 (mm)	0
Max. lift height	h3 (mm)	3000
Height, mast extended	h4 (mm)	3455
Height of tiller in drive position min./max.	h14 (mm)	670/1300
Overall length	l1 (mm)	1950
Length to face of forks	l2 (mm)	878
Overall width	b1 (mm)	820
Fork dimensions	s/e/l (mm)	60/180/1070 (1150)
Width overall forks	b5 (mm)	570/695
Aisle width for pallets 800x1200 lengthways	Ast (mm)	2420
Turning radius	Wa (mm)	1575
Drive motor power	kW	1.2
Lift motor power	kW	3
Sound level at the driver's ear according to DIN12503	dB (A)	70
Travel speed, laden/unladen	Km/h	5.8/6
Lift speed, laden/unladen	m/s	0.11/0.15
Lowering speed, laden/unladen	m/s	0.12/0.12
Battery voltage, nominal capacity K (Duplex Mast)	V/Ah	24/240
Battery voltage, nominal capacity K (Triplex Mast)	V/Ah	24/240
Battery weight	Kg	220
Battery dimensions l/w/h	mm	625x254x500
Service weight (with battery)	Kg	1140/1190/1200/1290/1370/1400/1530

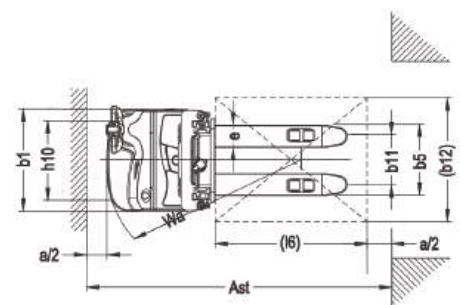
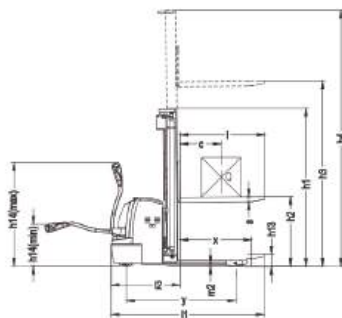

Think outside the box



Drive-in Drive Thru Pallet Racking



Modular Mezzanine Floor



Narrow Aisle Pallet Racking

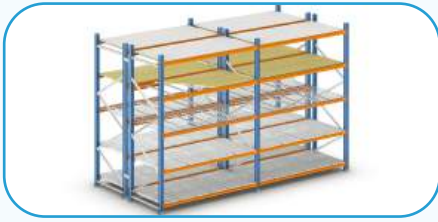

LONG SPAN SHELVING RACK



Boltless Long Span Shelving Rack



Multi Tier Long Span Shelving Rack



Cantilever Racking



M.S Powder Coated Cupboard



Rivet Shelving Rack



Mobile Shelving Rack, Compactor



M.S Powder Coated Lockers



Electric Forklift

www.reliablestorage.co.in



RELIABLE
STORAGE SYSTEMS

ADDRESS :- 103, Lake View Residency, Bhabola - Bangli Road,
Near Husaini Colony, Sandor , Vasai(W),
Dist. Palghar Pin.401 207 Maharashtra, India.

FACTORY :- Unit no. 15, 16, 17, 18 Mamta Compound,
Near Neel Kant Industrial Estate, Vilage
Devdal, Kaman, Vasai(E) - 401208 Maharashtra, India.

PHONE :- 98236 35153 | 98672 89052 | 9320011052

EMAIL :- sales@reliablestorage.co.in | inquiry@reliablestorage.co.in