

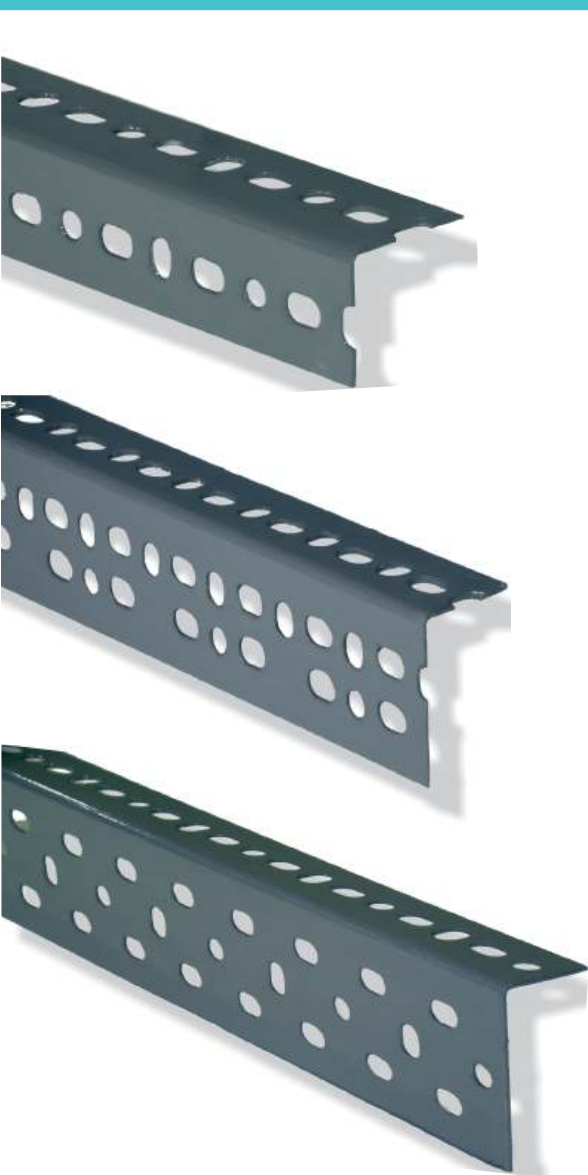

RELIABLE
STORAGE SYSTEMS

Slotted Angle & Shelving



*One Stop Storage Solution
In Industrial Racking System*

RELIABLE

Offers the widest range of slotted angle shelvings custom built to suit your specific needs supported by wide range of optional accessories like Cladding Sheets, Box Covers, Partition Plates, Panel guards, Punched Strips etc & load Carrying capacity ranging from 50 kgs to 600 kgs on each shelf. The entire components is made of finest quality of steel and is Phosphated, Stove enameled & oven baked at a temperature of 150°C



Plan it... Cut

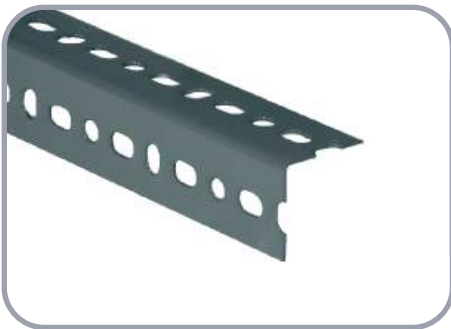

35 x 35

35mm x 35mm

35 x 35 x 1.6mm
 35 x 35 x 1.8mm
 35 x 35 x 2.0mm

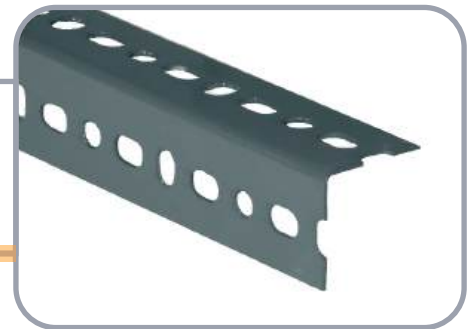

40 x 40

40mm x 40mm

40 x 40 x 1.6mm
 40 x 40 x 1.8mm
 40 x 40 x 2.0mm

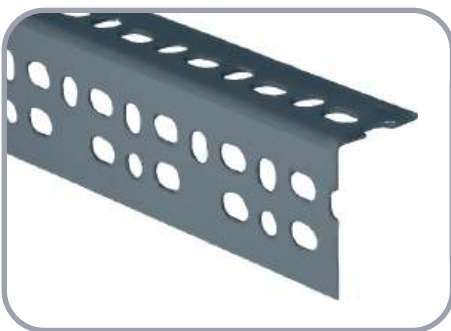

60 x 40

60mm x 40mm

60 x 40 x 1.6mm
 60 x 40 x 1.8mm
 60 x 40 x 2.0mm

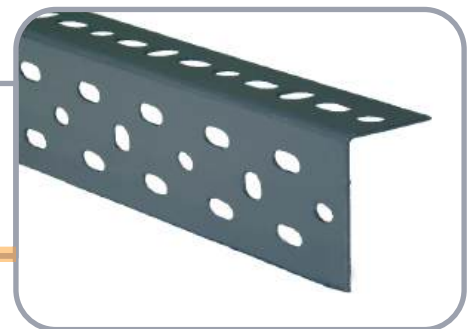

80 x 40

80mm x 40mm

80 x 40 x 2.00mm
 80 x 40 x 2.25mm
 80 x 40 x 2.50mm

Above Slotted Angle available in length of 1.8, 2.0, 2.5 & 3.0 Mtr.

Slotted angle with other thickness can be made as per customer's requirement.

RELIABLE Special Slotted Channel / Grating

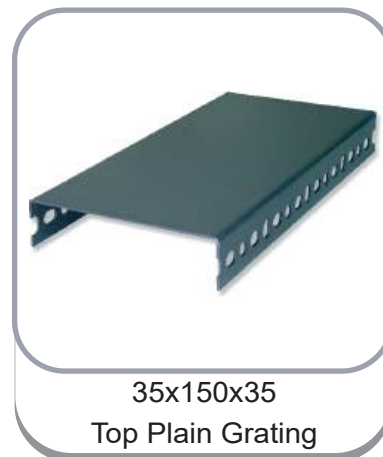
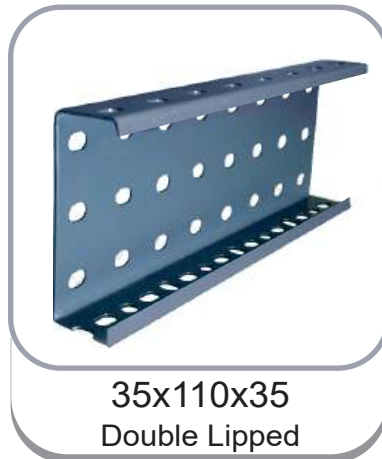

The combination of these channels can be used for making Mezzanine Floors, Walkway, Catwalk, Heavy Duty Structure, Platform, etc.. Above "C" Channels are available in length of 1.8, 2.0, 2.5 & 3.0 Mtr.



M.S. SHELVES

Size in mm	Approx Inch	Size in mm	Approx Inch	Size in mm	Approx Inch
750 x 225	30" x 09"	900 x 225	36" x 09"	1200 x 225	48" x 09"
750 x 300	30" x 12"	900 x 300	36" x 12"	1200 x 300	48" x 12"
750 x 375	30" x 15"	900 x 375	36" x 15"	1200 x 375	48" x 15"
750 x 450	30" x 18"	900 x 450	36" x 18"	1200 x 450	48" x 18"
750 x 600	30" x 24"	900 x 600	36" x 24"	1200 x 600	48" x 24"

Thickness of shelves range from 0.70, 0.80, 0.90, 1.00, 1.20 and 1.60 mm to suite your needs with the option of re-inforcement stiffeners in the shelves. Shelves with other thickness can be made as per customer's requirement.



Sectional Panel

This sectional panel are used in medium & Heavy duty Racks.

Sectional Panel come in various Sizes of:-

Lenght - 600,750,900 and 1200 mm

Depth - 150, 225, 300, 375 and 450 mm

Thickness of Sectional panel range from:-

0.70, 0.80, 0.90, 1.00, 1.20 and 1.60 mm

depending upon the load, size & thickness of sectional panel is determine



it...

Build it...

ADD SPACE WITHIN SPACE

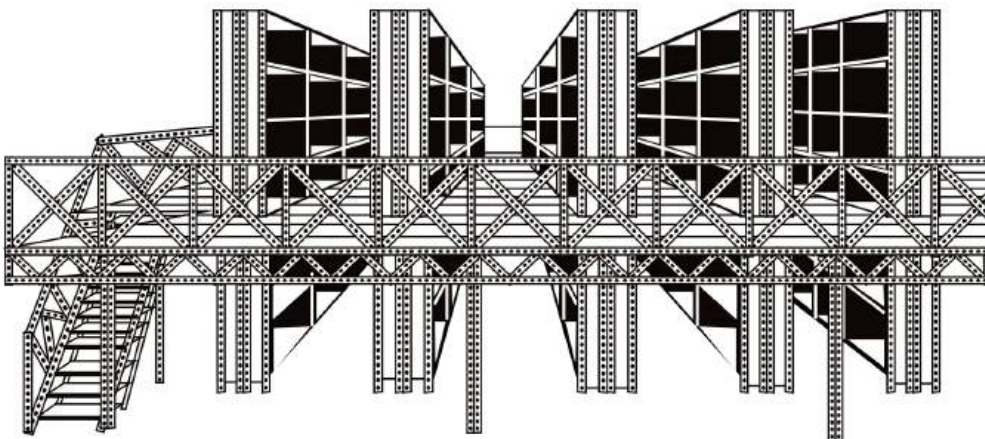

Two Tier Structure

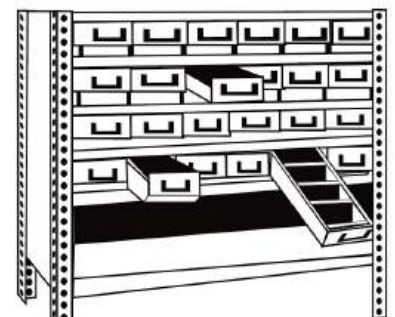

Drawers Rack

☐ COMPLETE DESIGN ☐ LAYOUT ☐ CAD DRAWINGS ☐ INSTALLATION

For an additional update on us, pleas visit us at : www.reliablestorage.co.in



Nuts and Bolts

To calculate amount of nuts and bolts needed, multiply number of corners or joints by 3.



Plastic Feet

Available in sizes:
 40 "L" & "T"
 60 "L" & "R"
 80 "L" & "R"

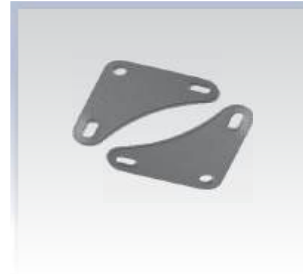

Corner Plates

To ensure rigid structures when using 140 or 160 Angle, Corner Plates are fixed between the faces of the angles.

Use it.

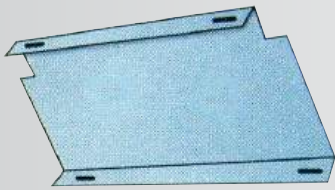

PARTITION PLATE

- Used for partition standard type shelves into pigeon holes.
 Please specify height dimension X depth dimension when ordering

CLADDIND SHEET

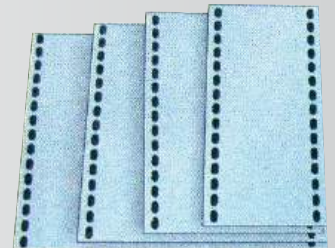

- All 1000mm height in Standard width

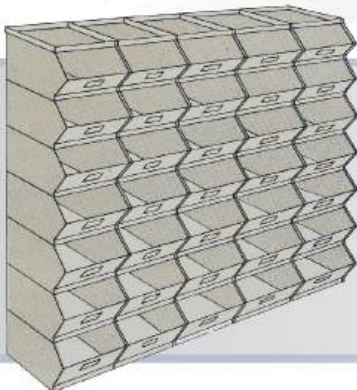

M.S. Stack Bins

M.S. Stack Bins

Model No.	Length	Width	Depth	Max Loading
RSSB1.	175	100	100	4kgs
RSSB2.	225	125	125	8kgs
RSSB3.	300	150	150	15kgs
RSSB4.	400	215	200	35kgs
RSSB5.	500	260	220	40kgs
RSSB6.	500	380	220	50kgs



Slotted Angle Shelving Racks



Slotted Angle Pigeon Hole Rack



Sectional Panel Rack



Slotted Angle Pipe Racks



Slotted Angle Enclosed Racks
with Wire Mesh Doors



Slotted Angle Staircase

Think outside the box



Drive-in Drive Thru Pallet Racking



Modular Mezzanine Floor



Narrow Aisle Pallet Racking



LONG SPAN SHELVING RACK



Boltless Long Span Shelving Rack



Multi Tier Long Span Shelving Rack



Cantilever Racking



M.S Powder Coated Cupboard



Rivet Shelving Rack



Mobile Shelving Rack, Compactor



M.S Powder Coated Lockers



Electric Forklift

www.reliablestorage.co.in



RELIABLE
STORAGE SYSTEMS

ADDRESS :- 103, Lake View Residency, Bhabola - Bangli Road,
Near Husaini Colony, Sandor , Vasai(W),
Dist. Palghar Pin.401 207 Maharashtra, India.

FACTORY :- Unit no. 15, 16, 17, 18 Mamta Compound,
Near Neel Kant Industrial Estate, Vilage
Devdal, Kaman, Vasai(E) - 401208 Maharashtra, India.

PHONE :- 98236 35153 | 98672 89052 | 9320011052

EMAIL :- sales@reliablestorage.co.in | inquiry@reliablestorage.co.in